

# Number Activities

## Table Of Contents

	<b>Page</b>
Missing Numbers (5 pages) .....	2
Dot to Dot (5 pages) .....	7
Trace the Numbers (2 pages) .....	12
Connect the Numbers to Its Word (2 pages) .....	14
Color the Numbers (2 pages) .....	16
Color by Numbers (3 pages) .....	18
Circle the Matching Number (3 pages) .....	21
Count and Write (3 pages) .....	24
Count and Connect (3 pages) .....	27
Choose the Right Answer (3 pages) .....	30
Find And Color (2 pages) .....	33
Number Poster (5 pages) .....	35

# MISSING NUMBERS

Write the missing numbers.

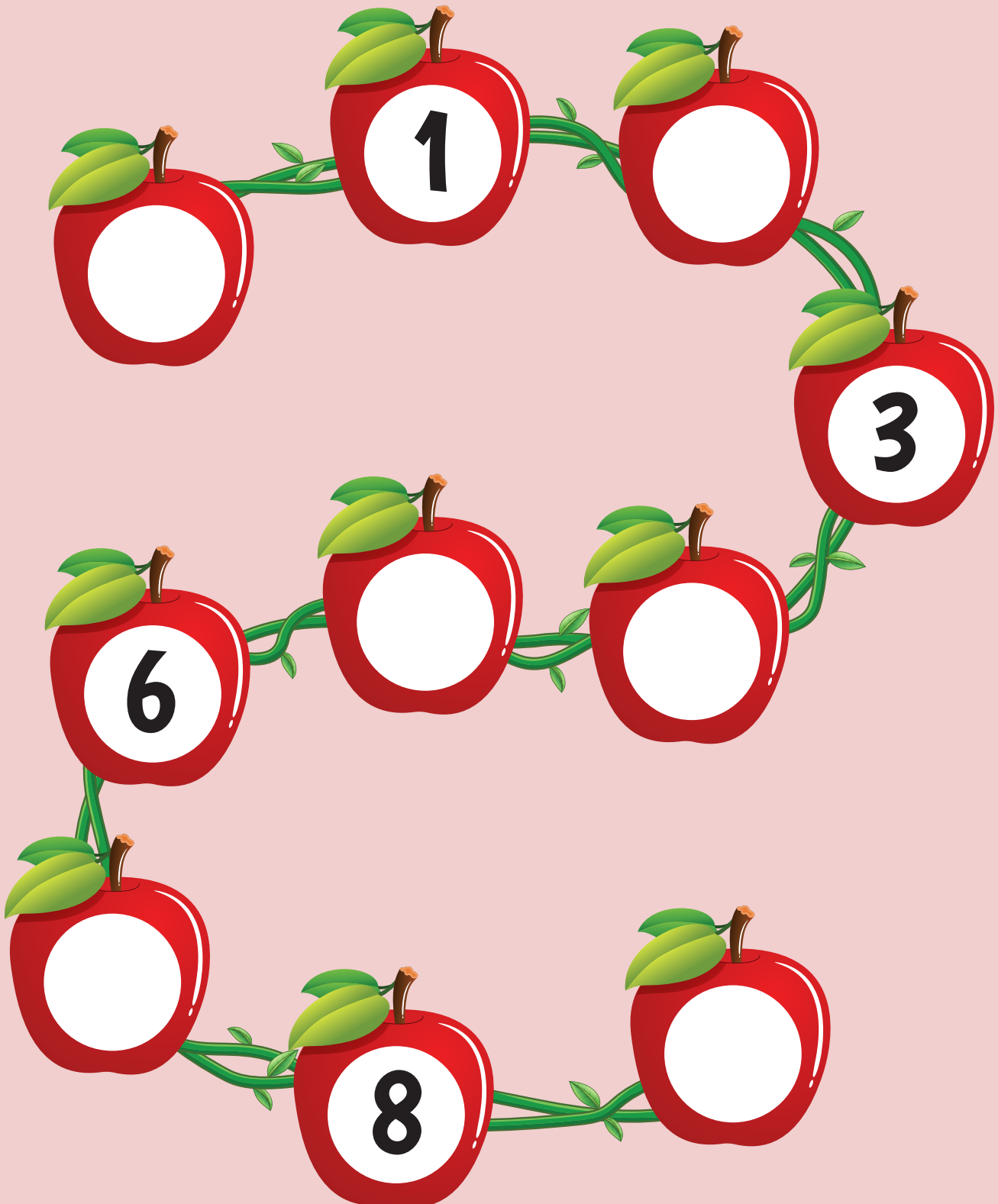

# MISSING NUMBERS

Write the missing numbers.

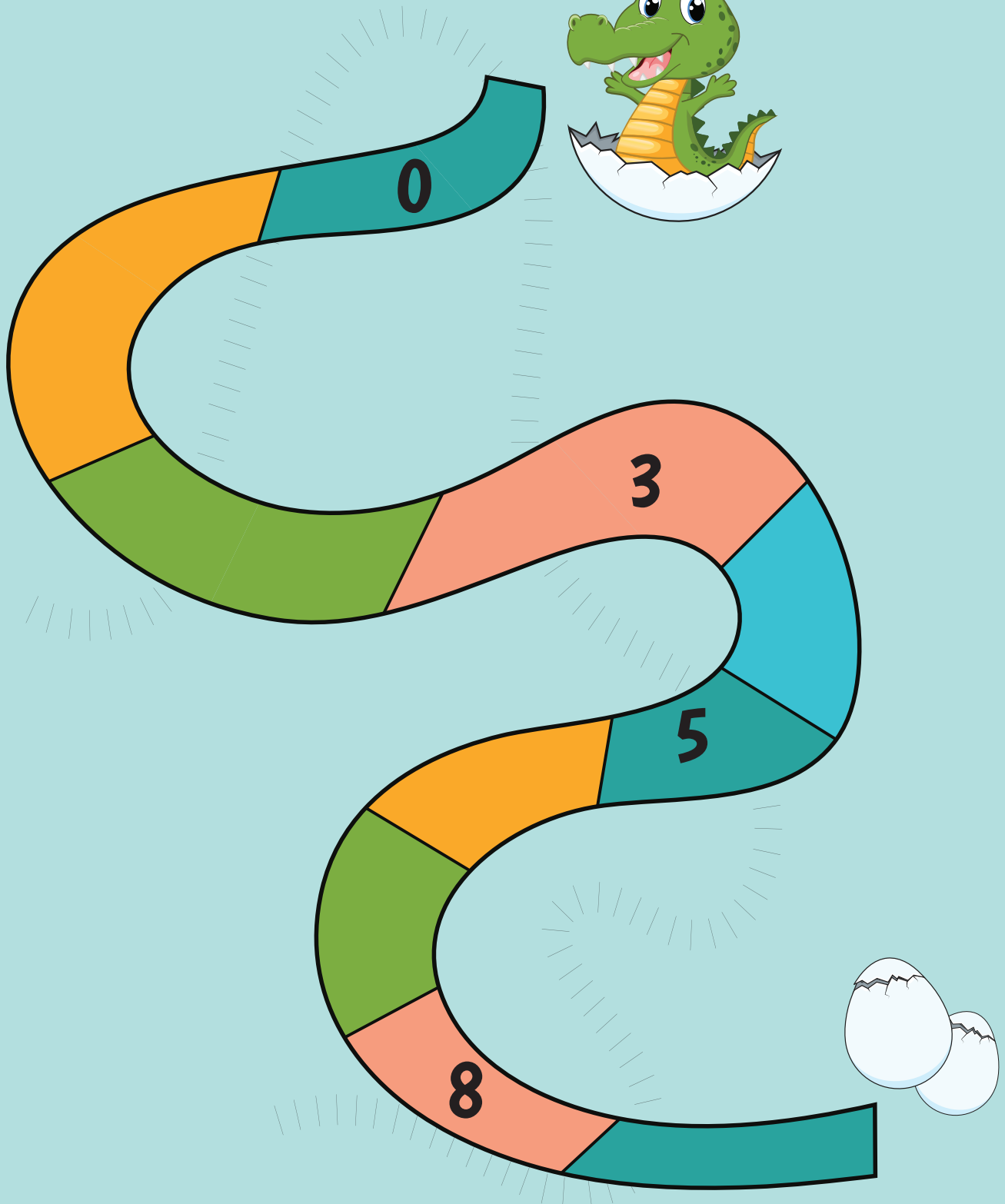

# MISSING NUMBERS

Write the missing numbers.

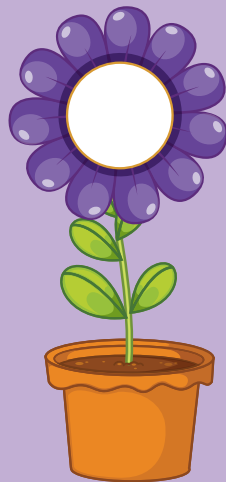
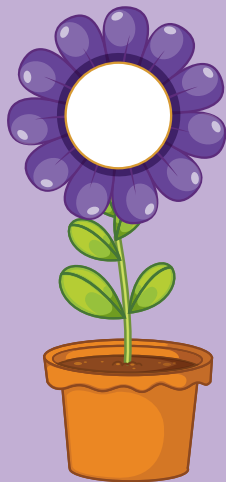
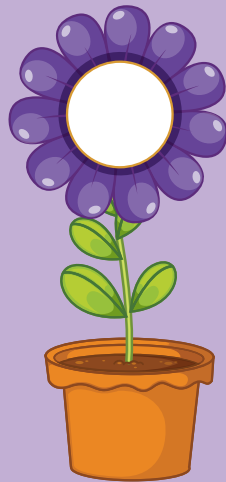
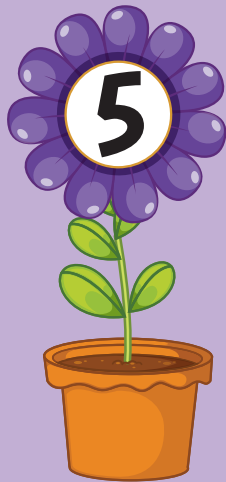
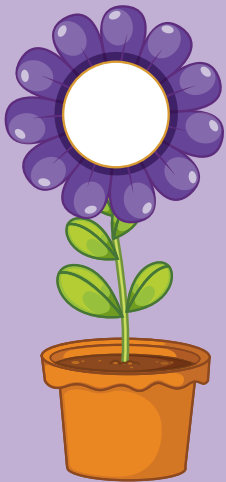



# MISSING NUMBERS

Write the missing numbers.

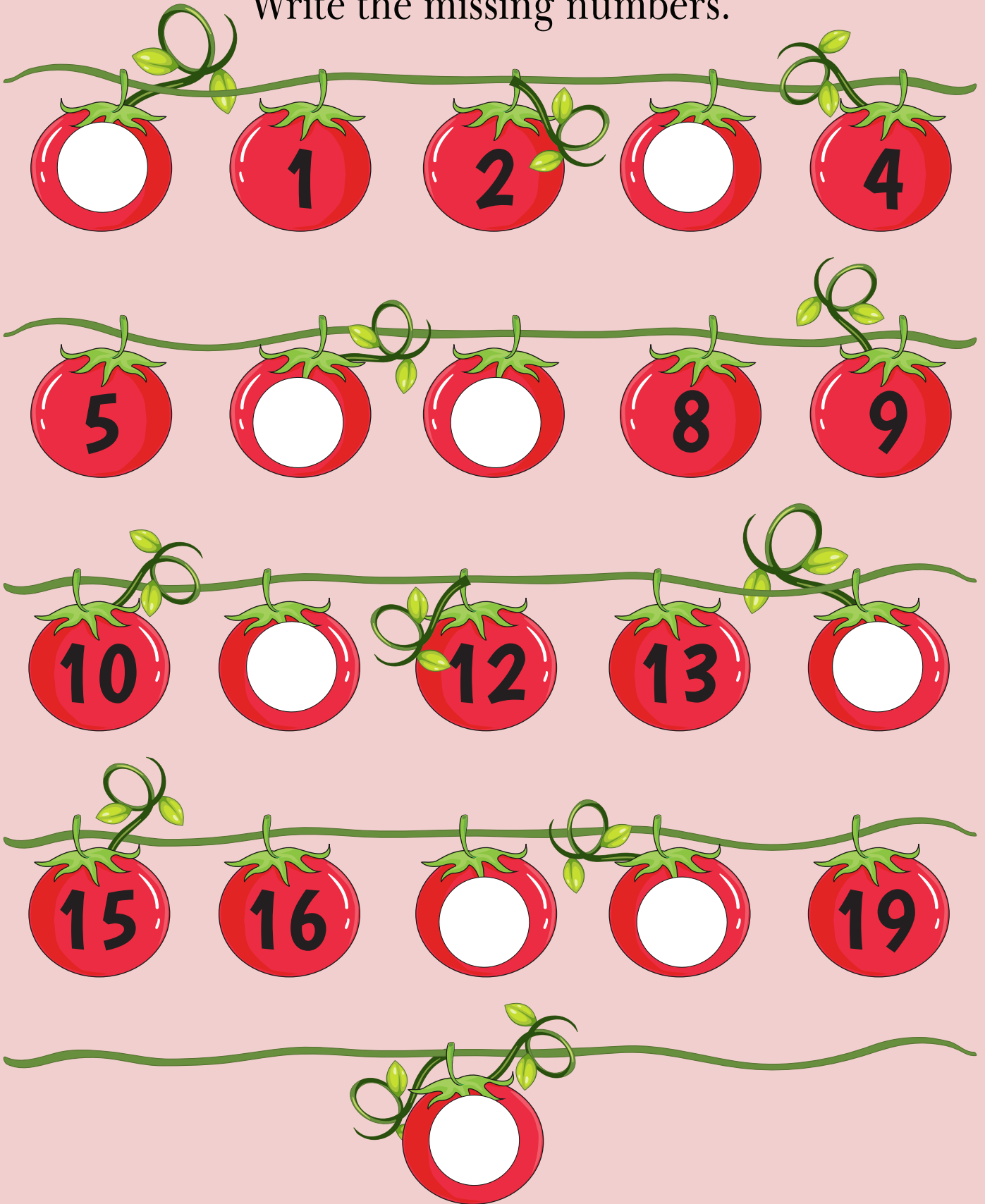

# MISSING NUMBERS

Write the missing numbers.

0

3

5

7

10

12

13

15

17

20

# DOT TO DOT

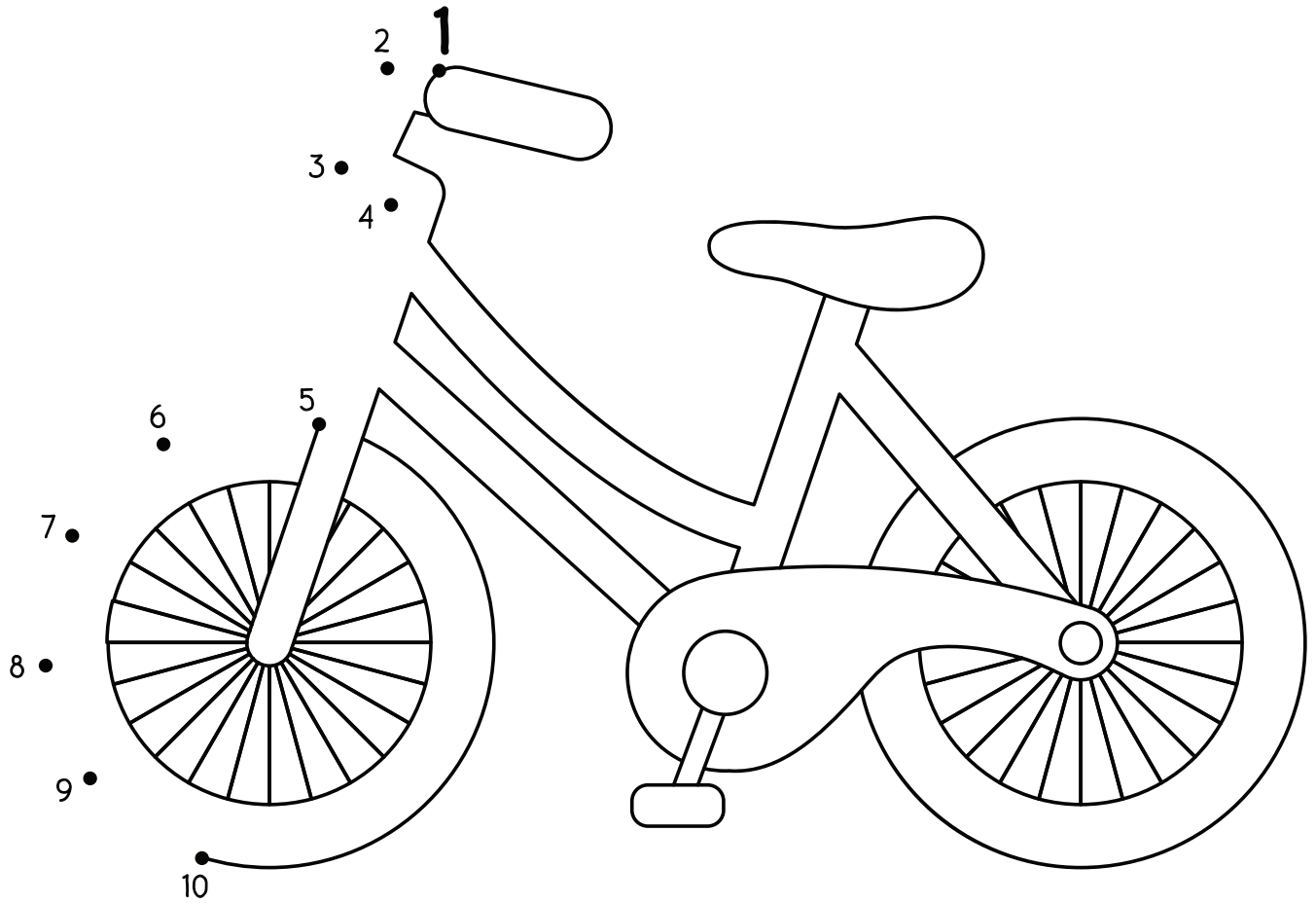

# DOT TO DOT

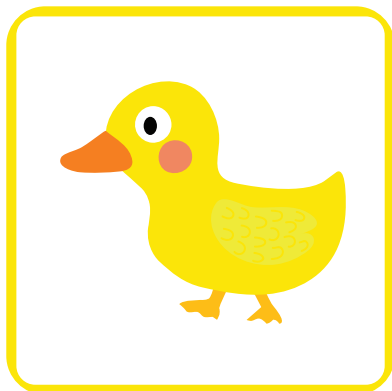
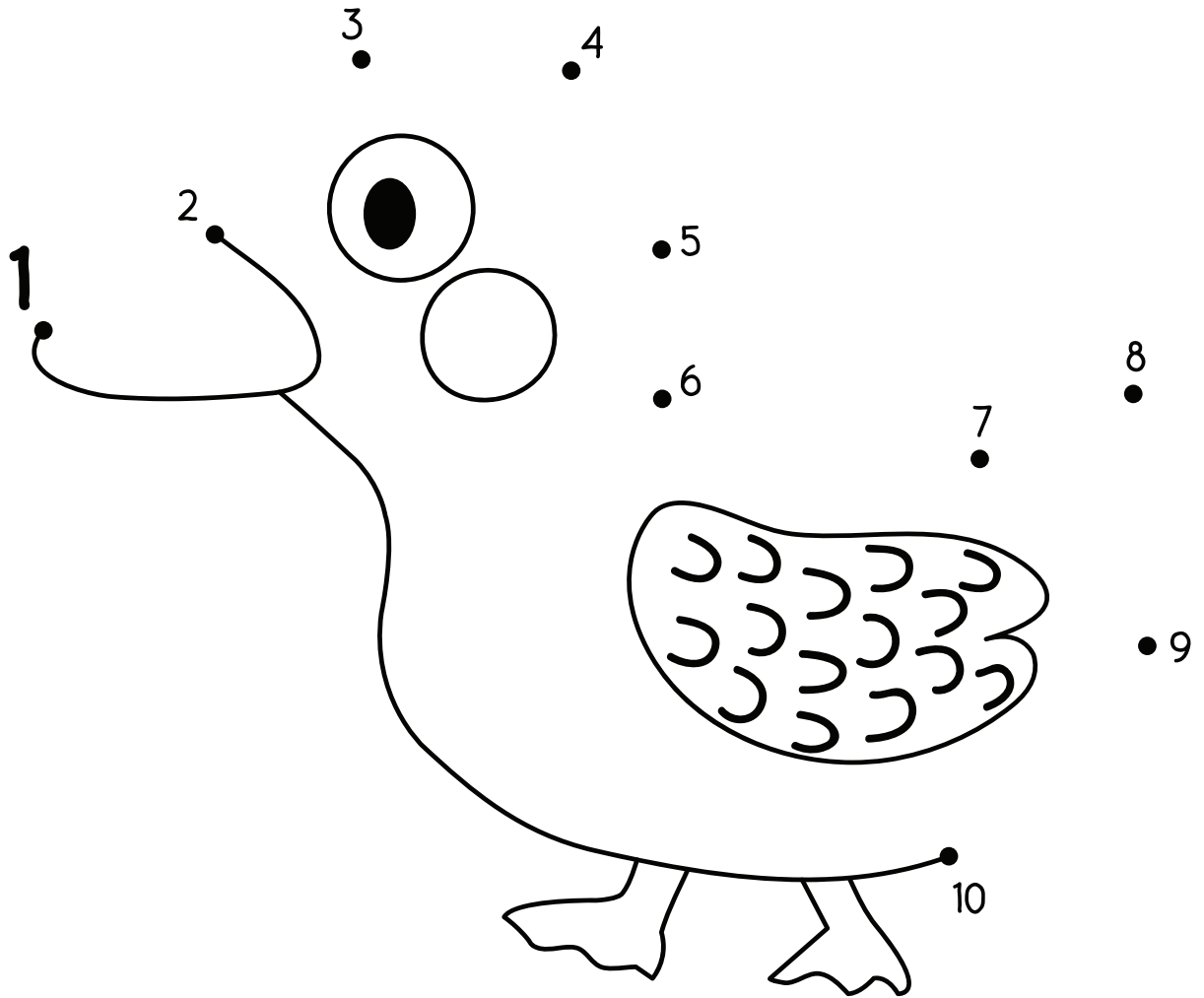

# DOT TO DOT

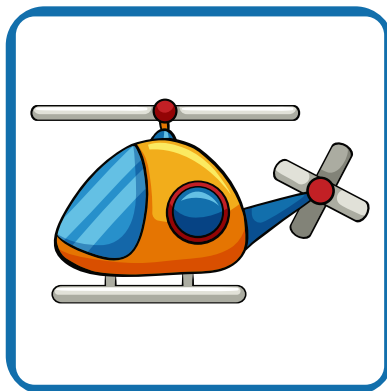
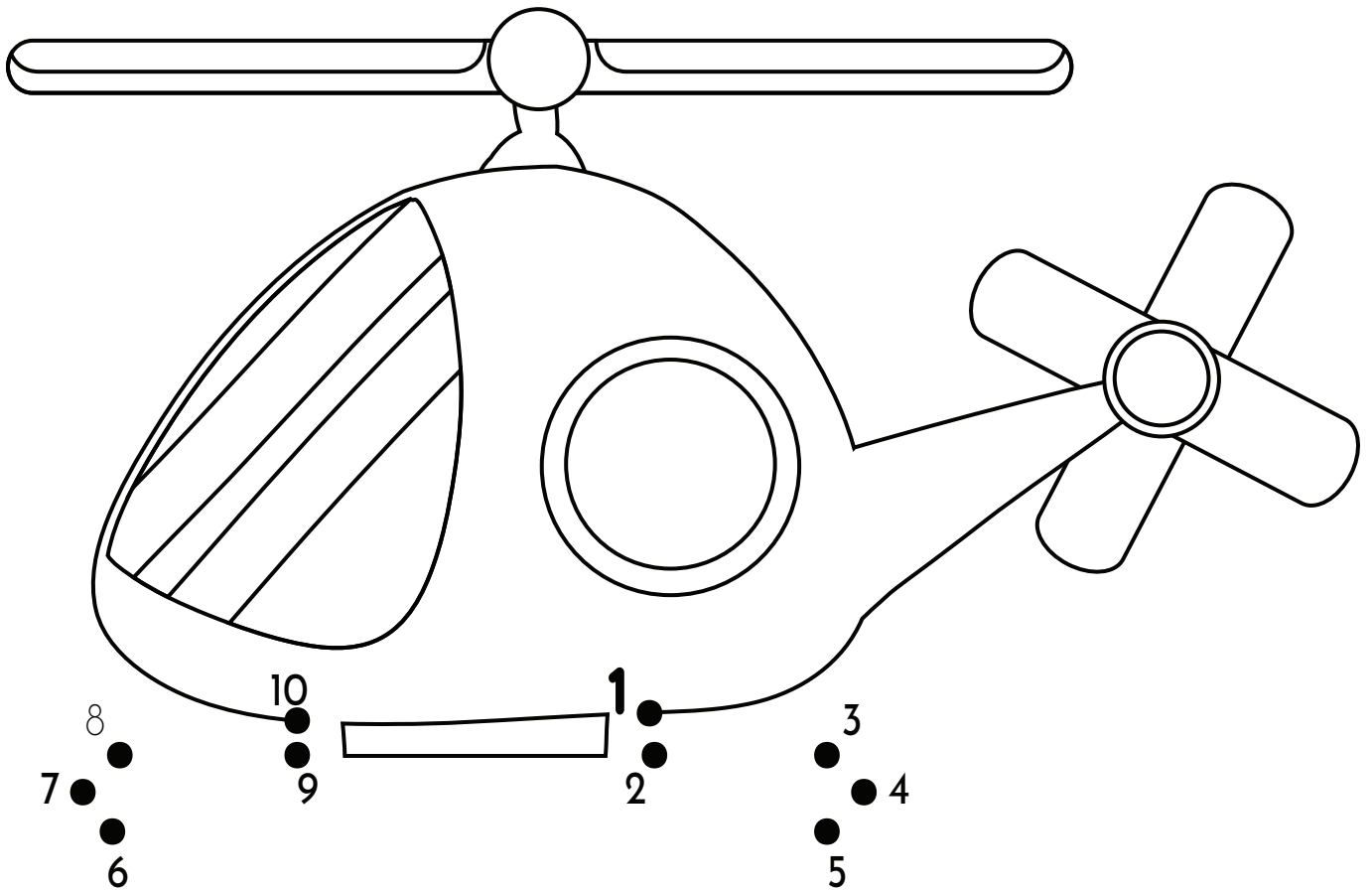

# DOT TO DOT

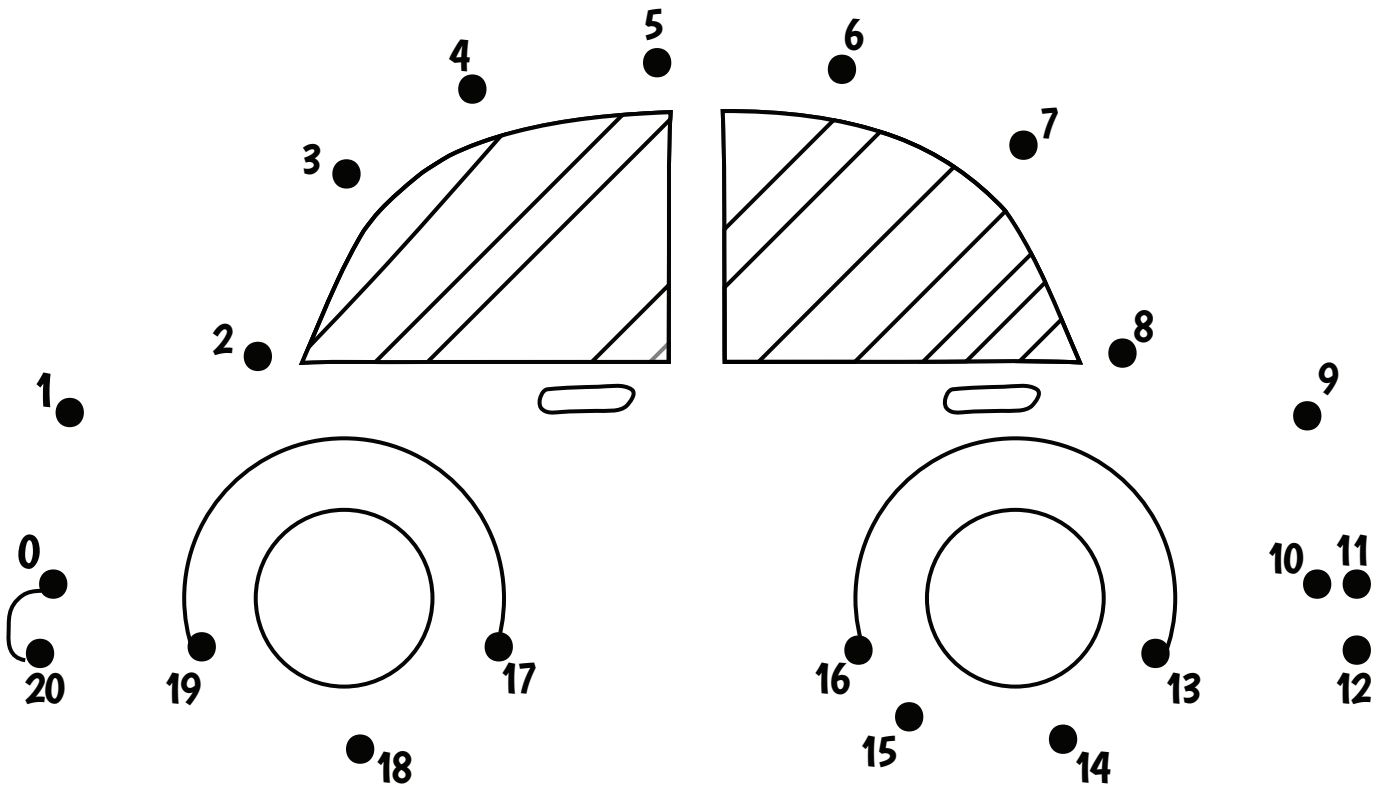

# DOT TO DOT

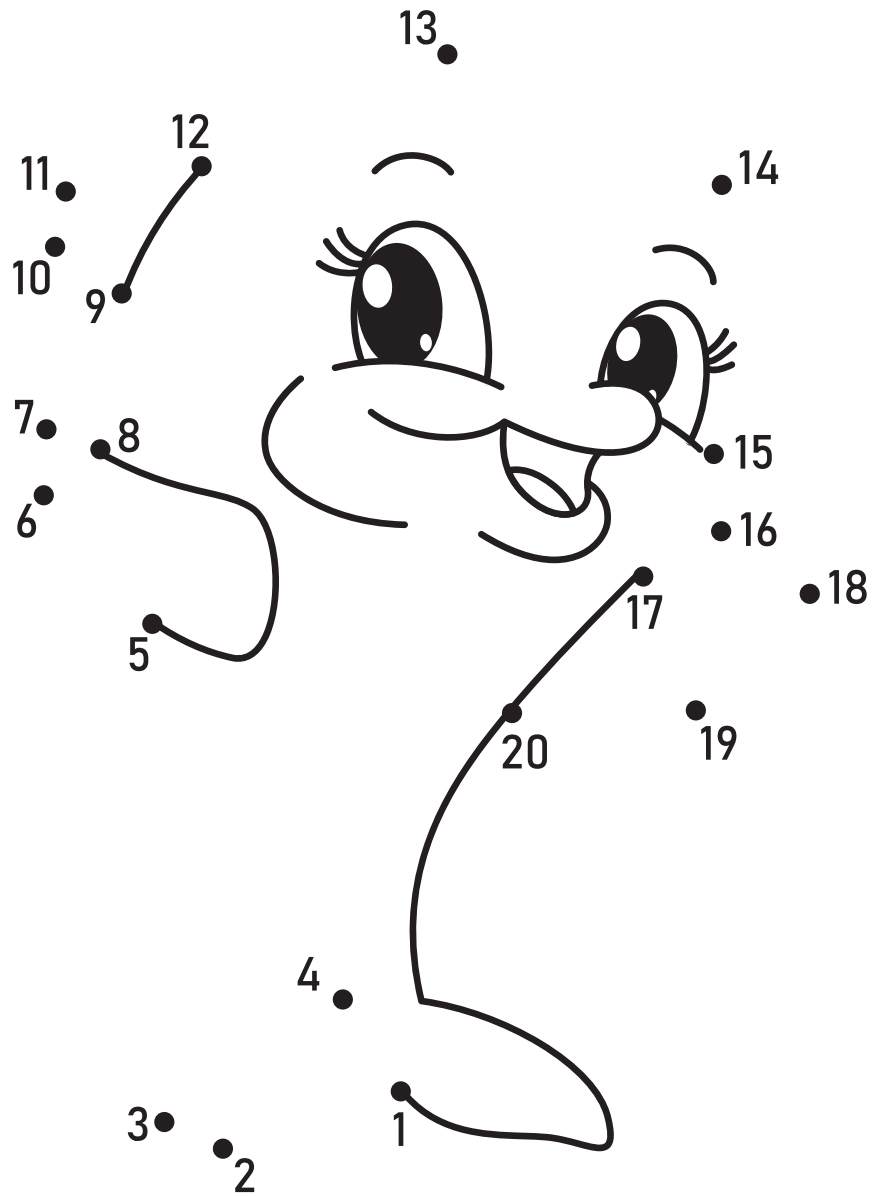

# TRACE THE NUMBERS

0 0 0 0 0 0 0

1 1 1 1 1 1 1

2 2 2 2 2 2 2

3 3 3 3 3 3 3

4 4 4 4 4 4 4

5 5 5 5 5 5 5

6 6 6 6 6 6 6

7 7 7 7 7 7 7

8 8 8 8 8 8 8

9 9 9 9 9 9 9



# TRACE THE NUMBERS

11

11

11

11

11

11

12

12

12

12

12

12

13

13

13

13

13

13

14

14

14

14

14

14

15

15

15

15

15

15

16

16

16

16

16

16

17

17

17

17

17

17

18

18

18

18

18

18

19

19

19

19

19

19

20

20

20

20

20

20

CONNECT THE NUMBER TO  
ITS WORD

8



zero

4



seven

7



eight

0



two

2



four

CONNECT THE NUMBER TO  
ITS WORD

3



five



9



three



1



six



5



one



6



nine



# COLOR THE NUMBERS

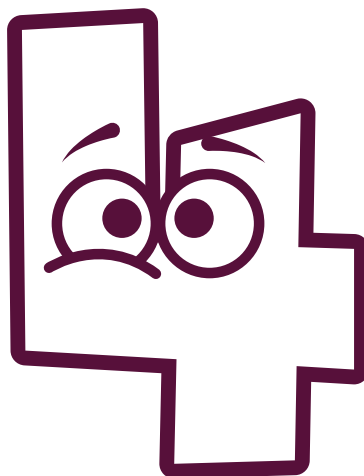
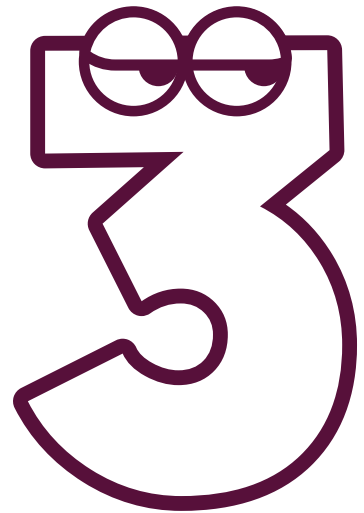
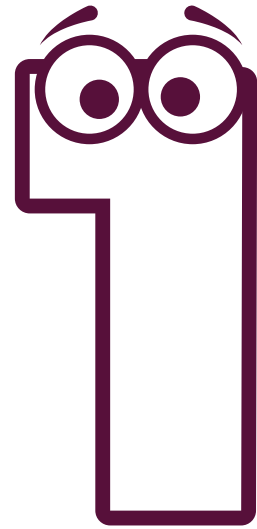
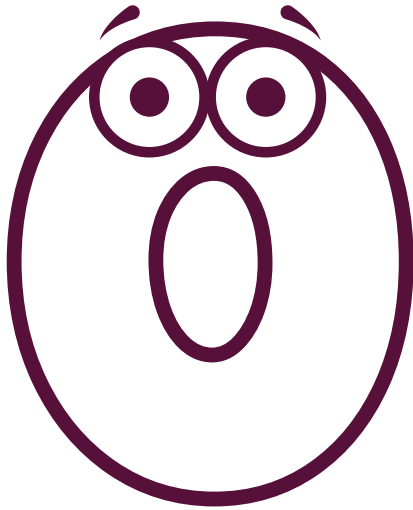

# COLOR THE NUMBERS

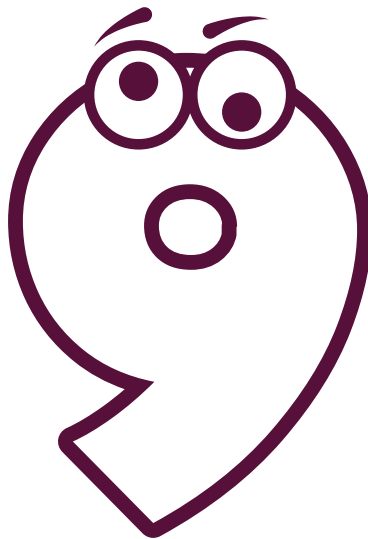
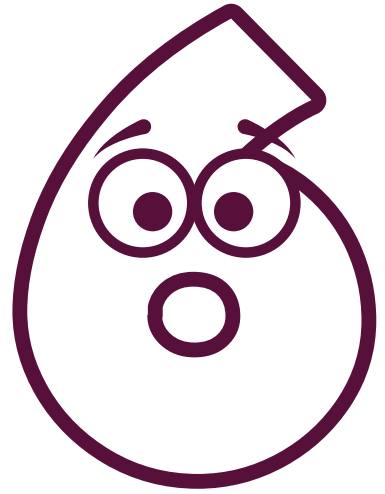

# COLOR BY NUMBERS

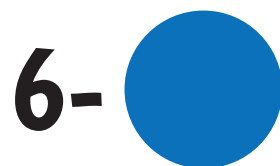
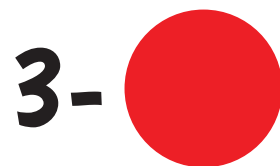
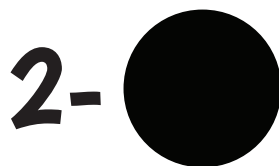
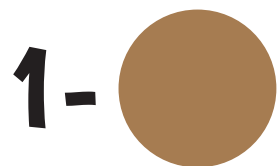
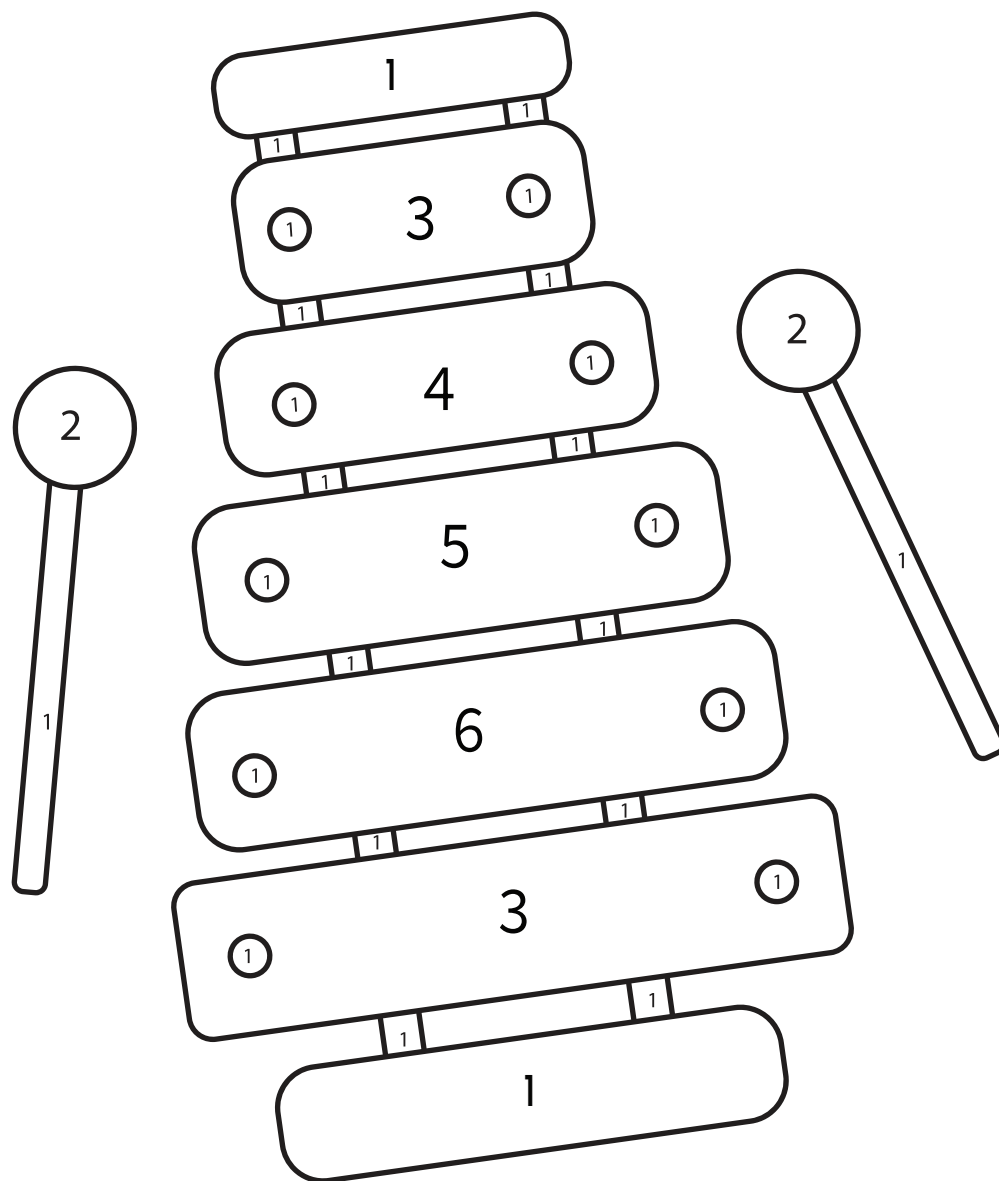

# COLOR BY NUMBERS

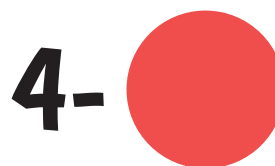
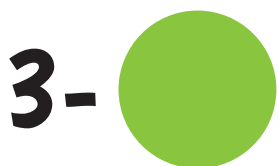
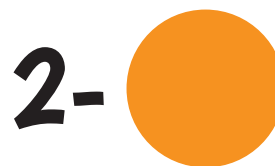
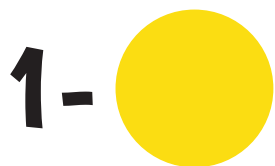
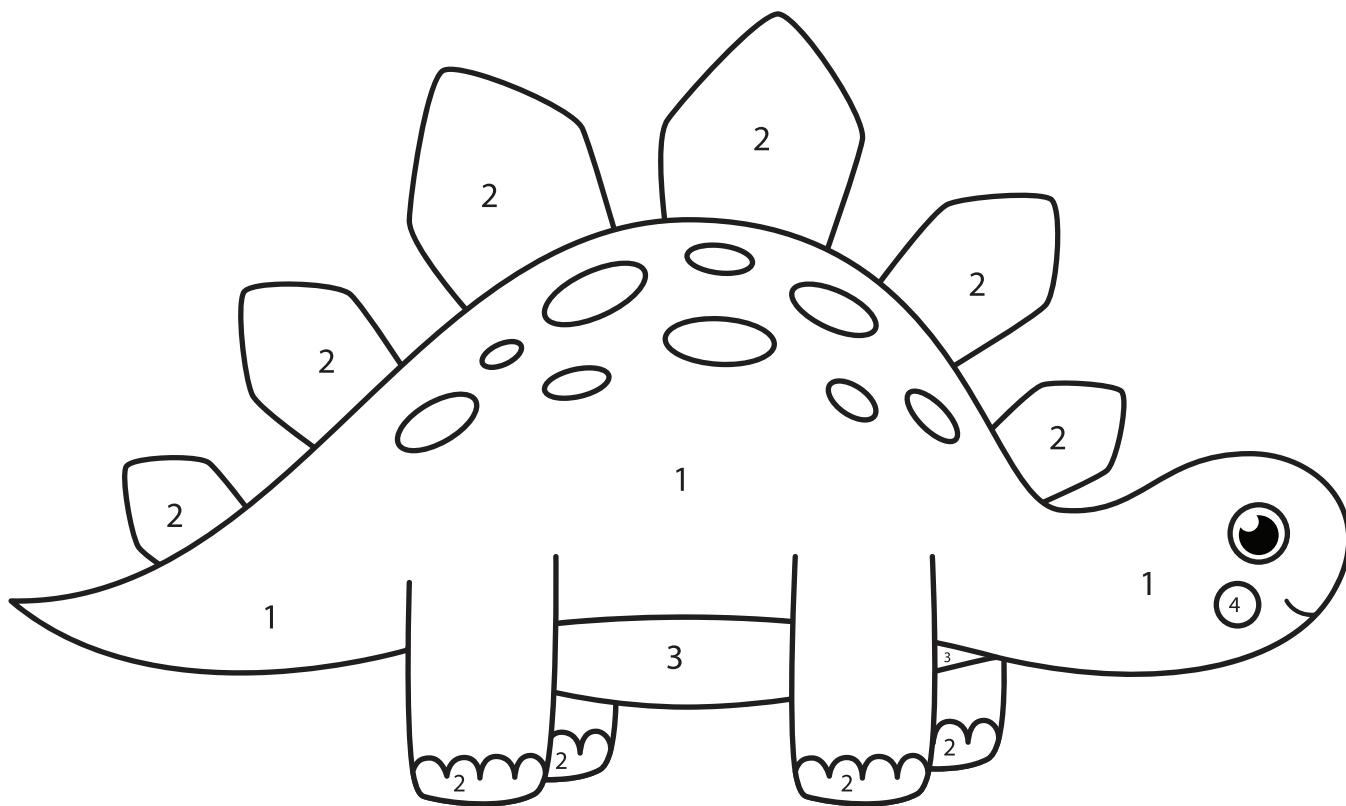

# COLOR BY NUMBERS

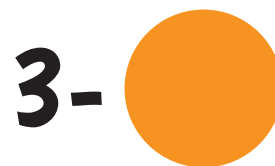
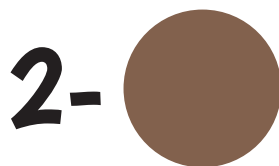
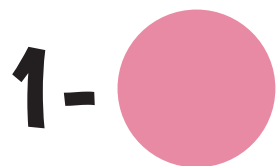
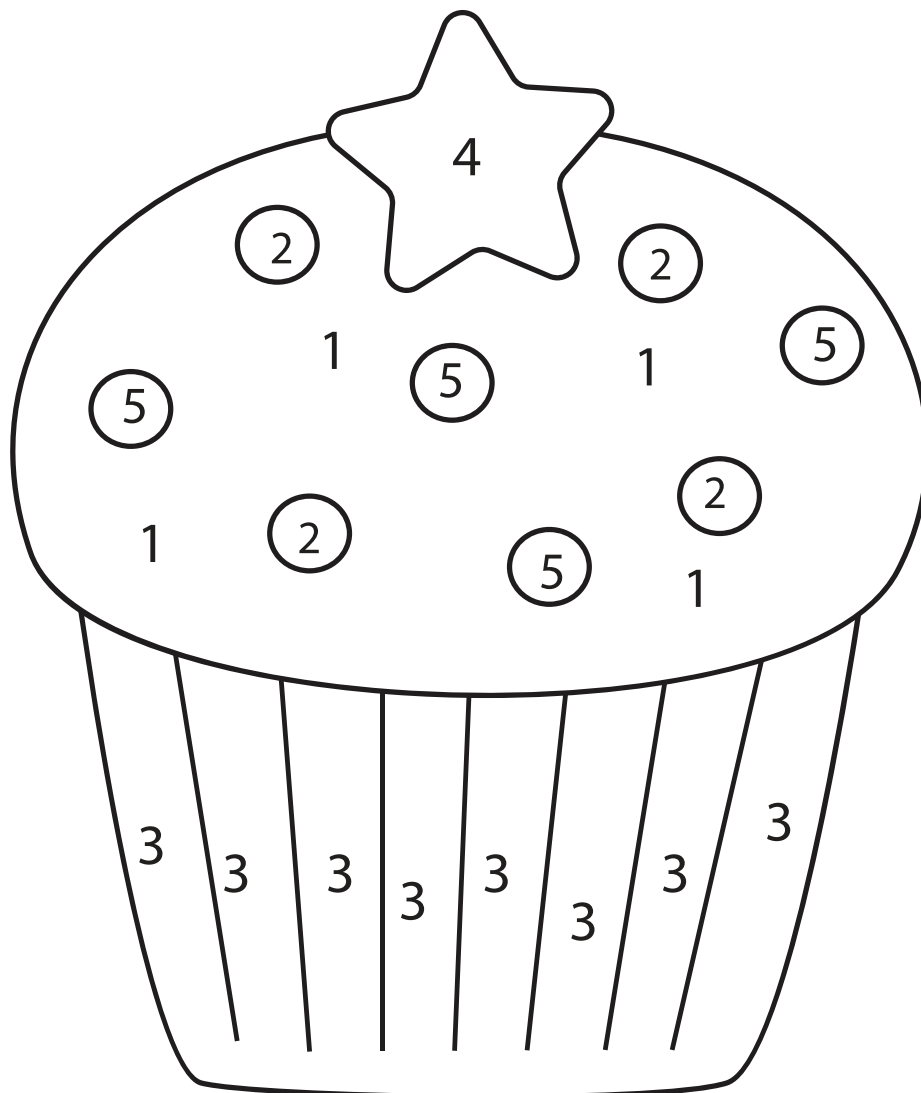



# CIRCLE THE MATCHING NUMBER

0	1 0 2 3 0
1	3 2 1 1 4
2	1 2 2 0 2
3	0 1 3 3 3
4	4 4 2 4 1

# CIRCLE THE MATCHING NUMBER

5	5 7 5 5 6
6	9 6 6 8 6
7	7 7 8 7 5
8	6 8 0 8 8
9	9 9 6 9 3

# CIRCLE THE MATCHING NUMBER

4

2

4

4

8

7

7

1

2

7

7

4

3

7

3

8

3

3

9

6

5

9

9

2

0

8

0

6

0

9

# COUNT AND WRITE



# COUNT AND WRITE

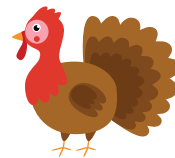
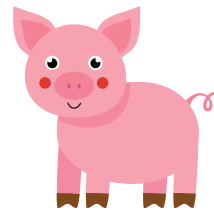
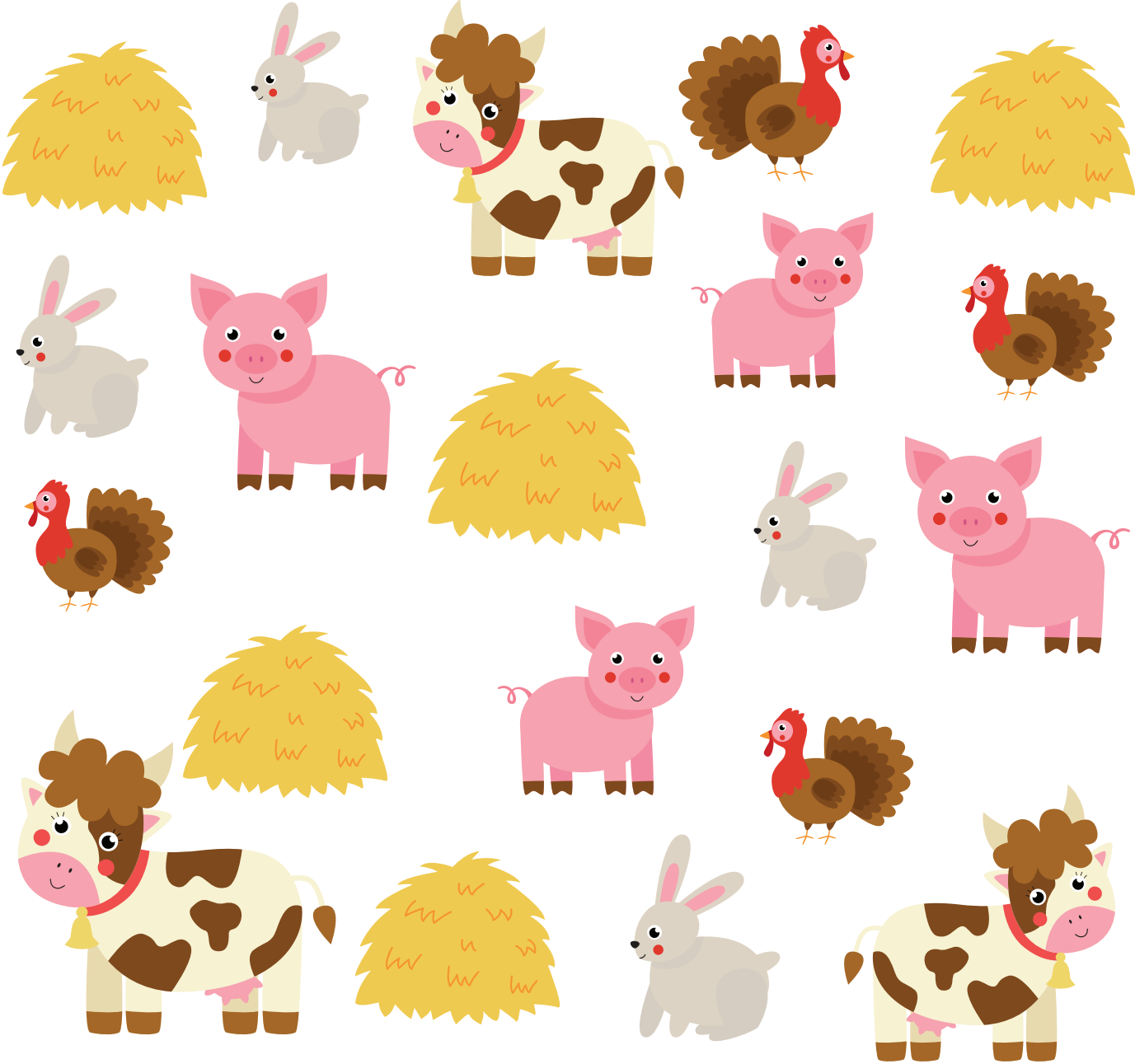

# COUNT AND WRITE

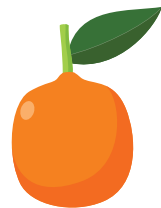
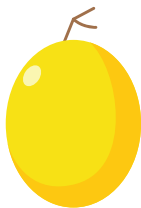
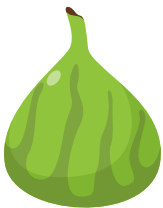
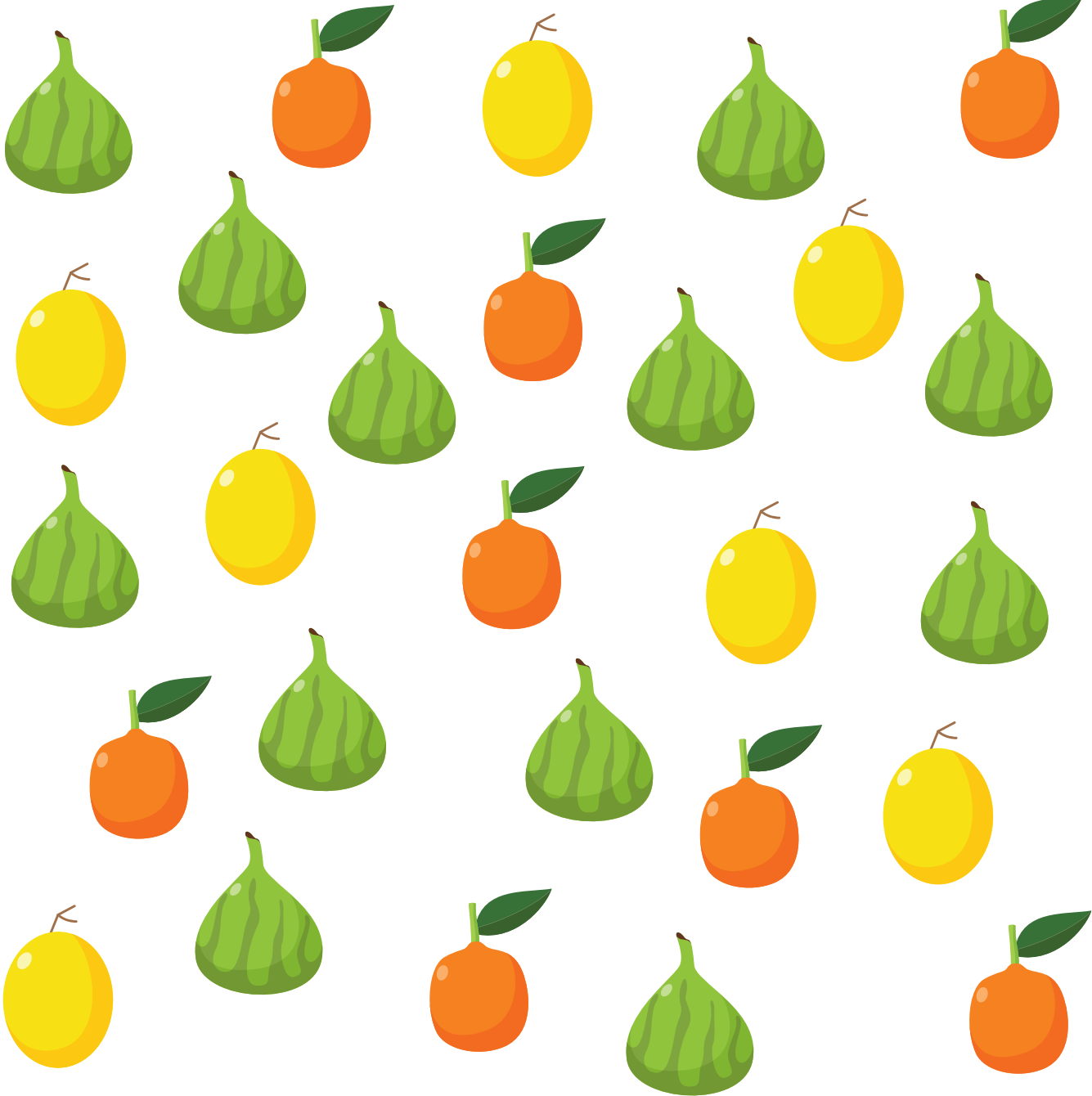

# COUNT AND CONNECT

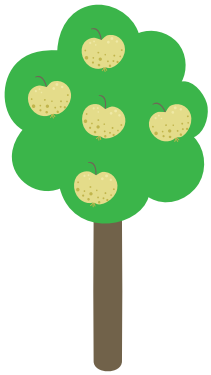

12

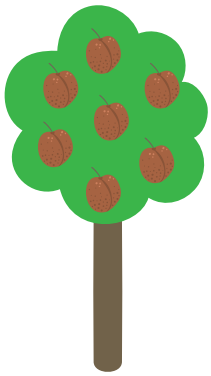

3

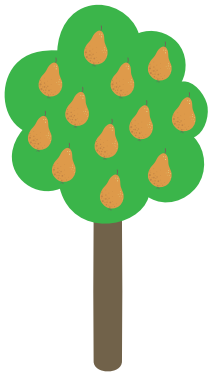

7

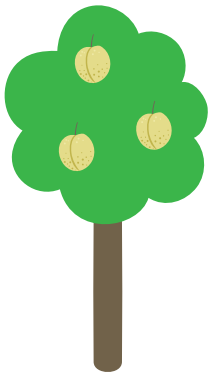

5

# COUNT AND CONNECT



4



2

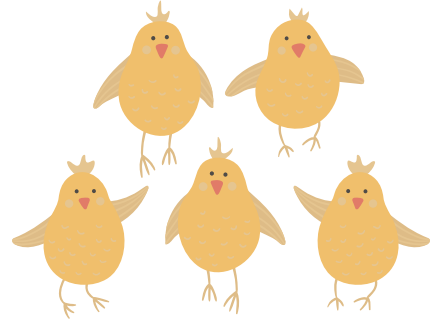

5

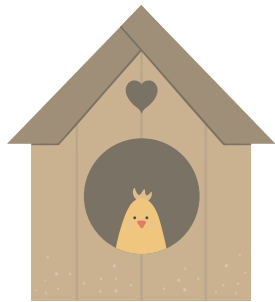
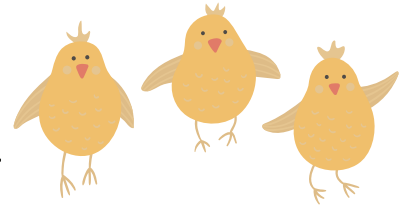

3

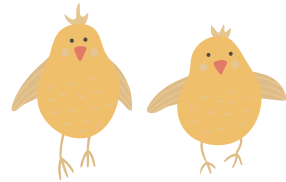

1

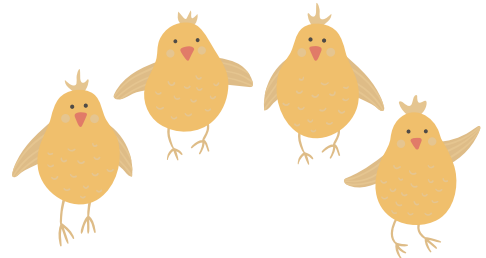



# COUNT AND CONNECT

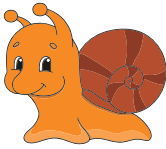
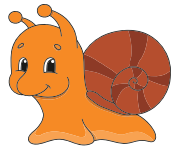
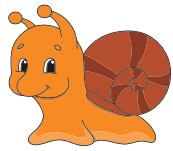

6



3



9



2

# CHOOSE THE RIGHT ANSWER

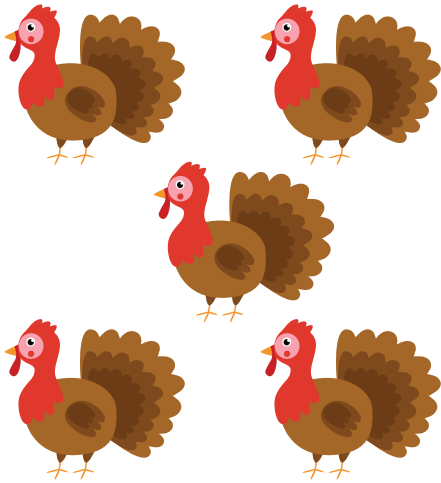
	4
	5
	6

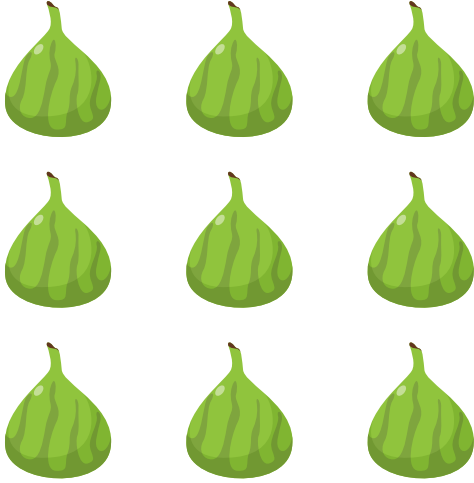
	7
	6
	9

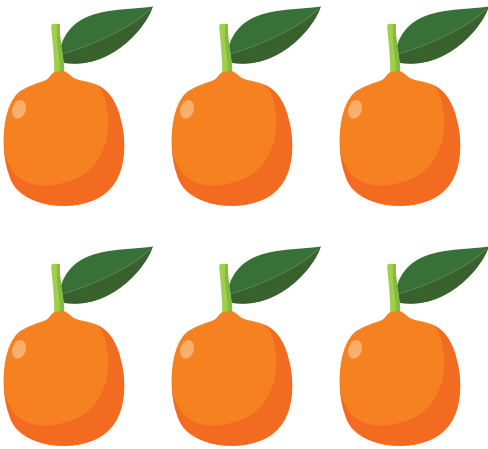

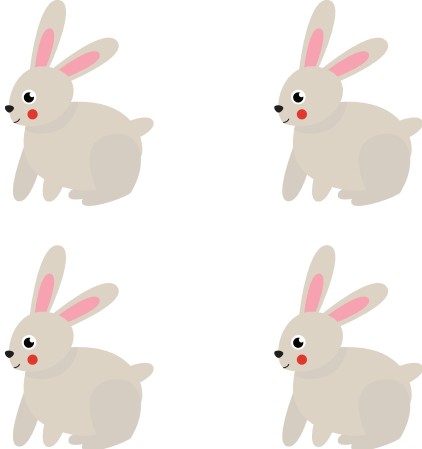
	6
	9
	4

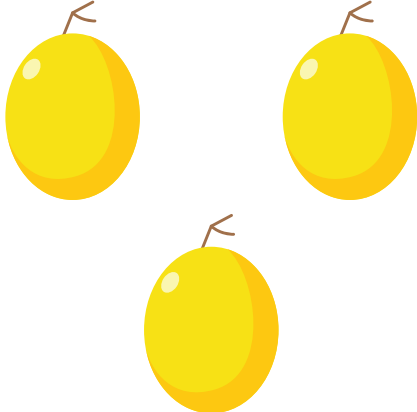

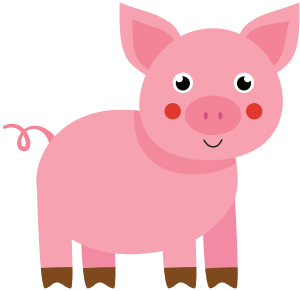

	1
	4
	3

	2
	1
	3



	4
	1
	0





# CHOOSE THE RIGHT ANSWER



	<b>6</b>
	<b>4</b>
	<b>8</b>

	<b>11</b>
	<b>13</b>
	<b>12</b>
	
	



	<b>0</b>
	<b>1</b>
	<b>3</b>



	<b>2</b>
	<b>3</b>
	<b>1</b>

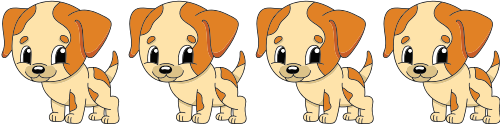

	<b>9</b>
	<b>10</b>
	<b>13</b>
	

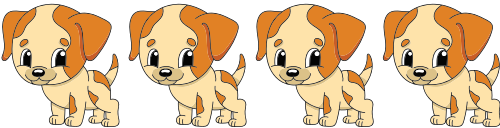

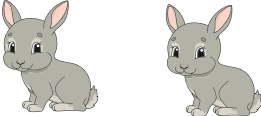
	<b>3</b>
	<b>2</b>
	<b>1</b>

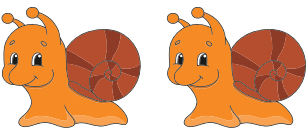

# CHOOSE THE RIGHT ANSWER

	<b>10</b>
	<b>9</b>
	<b>11</b>

	<b>11</b>
	<b>10</b>
	<b>12</b>

	<b>8</b>
	<b>7</b>
	<b>9</b>

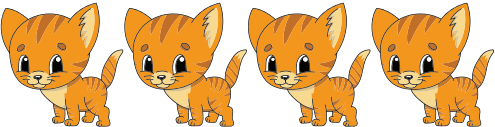
	<b>3</b>
	<b>4</b>
	<b>6</b>

	<b>16</b>
	<b>14</b>
	<b>18</b>

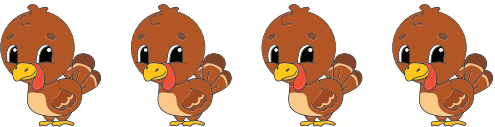
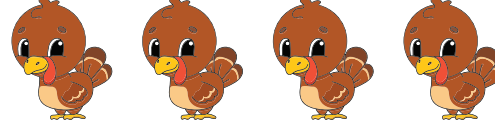
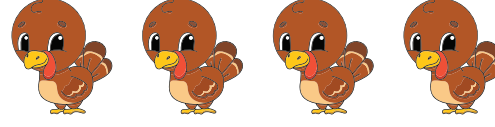
	<b>14</b>
	<b>12</b>
	<b>10</b>

# FIND AND COLOR

Color the box according to the color code.

2 = Yellow

8 = Red

3	7	4	0	8	8	5
1	0	3	8	6	1	8
10	6	5	8	9	9	8
7	10	3	9	8	8	9
2	2	2	8	3	1	8
2	6	2	8	9	9	8
0	2	4	6	8	8	9
2	6	10	4	1	6	9
2	2	2	10	7	3	9

# FIND AND COLOR







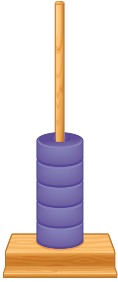

Color the box according to the color code.

7 = Pink

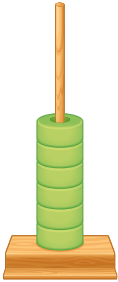
6 = Orange

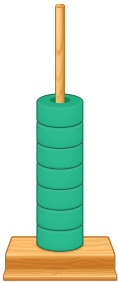
7	7	7	7	4	0	2
3	0	5	7	9	1	4
5	7	7	1	9	6	6
9	7	3	0	6	8	3
7	5	1	6	6	6	8
4	0	3	6	5	9	6
0	1	9	6	2	3	6
9	4	3	2	6	6	6
8	2	0	5	7	0	9

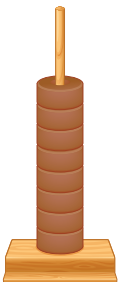
# NUMBERS 0-9

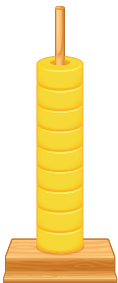
	<b>0</b> Zero		<b>5</b> Five
	<b>1</b> One		<b>6</b> Six
	<b>2</b> Two		<b>7</b> Seven
	<b>3</b> Three		<b>8</b> Eight
	<b>4</b> Four		<b>9</b> Nine

# NUMBERS 0-9

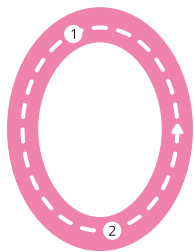

Zero

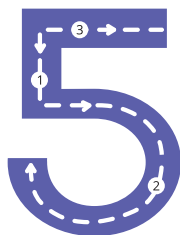

Five

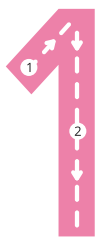
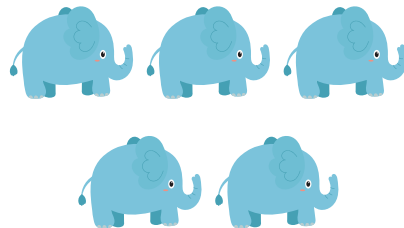

One

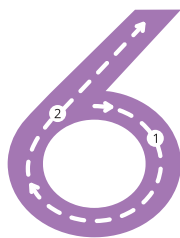
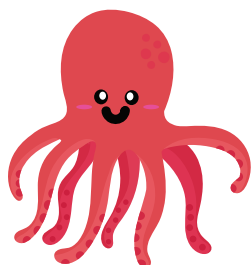

Six

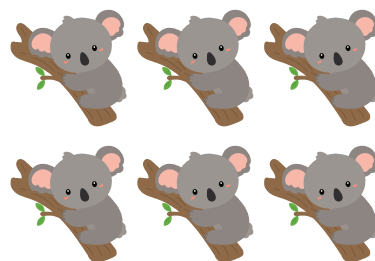

Two

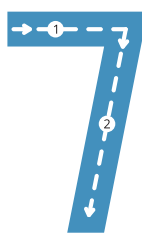
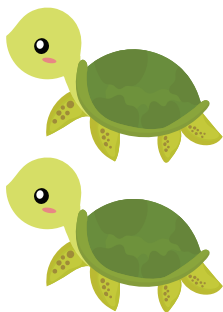

Seven



Three

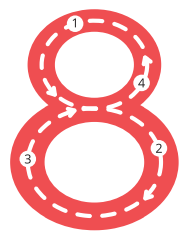
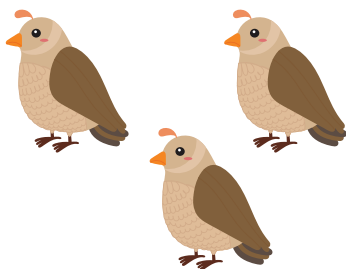

Eight

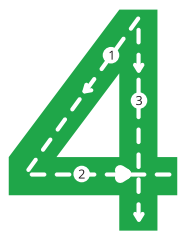
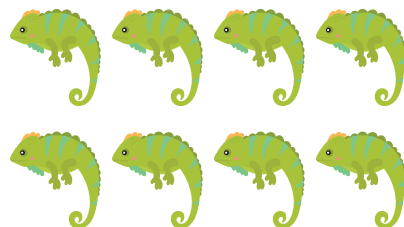

Four

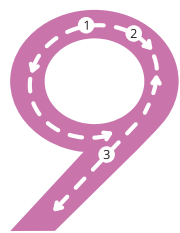

Nine

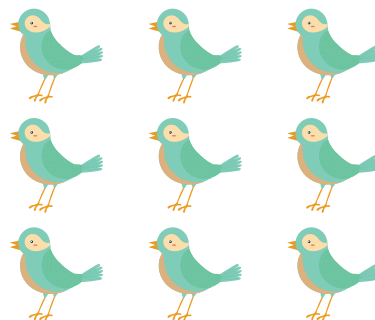



# NUMBERS 0-9



Zero

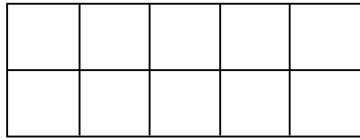

One

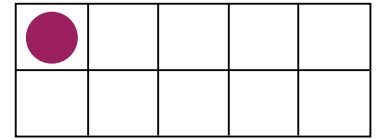

Two

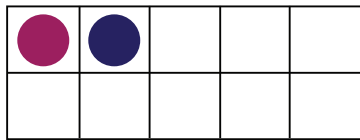

Three

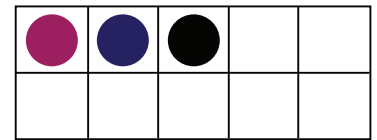

Four

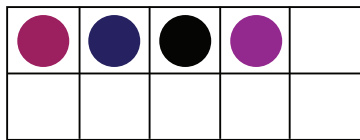

Five

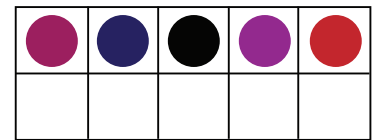

Six

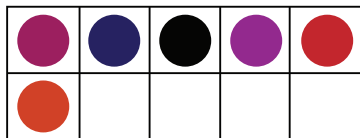

Seven

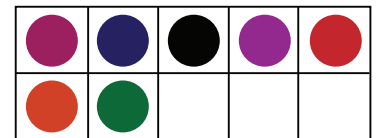

Eight

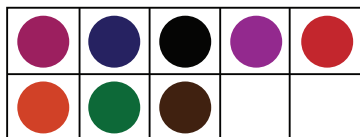

Nine

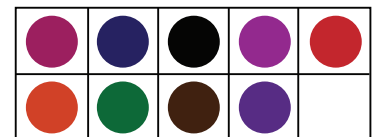

# NUMBERS 1-20

1

2

3

4

5

6

7

8

9

10

11

12

13

14

15

16

17

18

19

20

